

DENON

Hi-Fi Pre-Main Amplifier

SERVICE MANUAL MODEL PMA-730

SOLID STATE
PRE MAIN AMPLIFIER

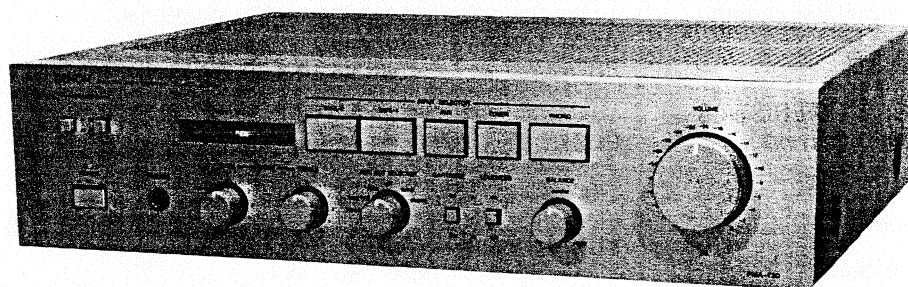

CONTENTS

SPECIFICATIONS	1
DESIGNATIONS AND FUNCTIONS OF FRONT PANEL CONTROLS	2
BLOCK DIAGRAM	2
METHOD OF ADJUSTMENTS	3
EXPLODED VIEW OF CABINET & CHASSIS	5
EXPLODED VIEW PARTS LIST	6
PRINTED WIRING BOARD PATTERNS AND PARTS LIST	
INPUT EQ. UNIT ETC-518K,M	7~9
POWER AMP UNIT ETC-519K,M	11
WIRING DIAGRAM	10
CONNECTION DIAGRAM	BOTTOM

NIPPON COLUMBIA CO., LTD.

SPECIFICATIONS

POWER AMPLIFIER SECTION

Rated Output Power:	Both channel drive 20 Hz to 20 kHz 60 W + 60 W (DIN, U.K., EUROPE, U.S.A.) (8 ohm Load) 1 kHz (4 ohm Load) 60 W + 60 W (DIN, U.K., U.S.A.) 1 kHz (4 ohm Load) 50 W + 50 W (IEC) (Subject to change by temperature test)
Total Harmonic Distortion:	0.009% (20 Hz – 20 kHz at –3 dB rated output 8 ohm Load) 0.05% (20 Hz – 20 kHz at rated output 8 ohm Load) (U.S.A.)
Intermodulation Distortion:	Below 7 kHz / 60 Hz : 1/4 0.002% (at amplitude output equivalent to rated output)
Output Band Width:	5 Hz – 80 kHz (IHF THD 0.1%)
Transmission Characteristics:	4 Hz – 150 kHz $+0$ dB -3 dB (at 1 W output)
Input Sensitivity:	150 mV
Input Impedance:	47 k ohm
Output Impedance:	0.01 ohm (1 kHz)
Output Terminals:	Speaker: A and B Load 4 – 16 ohm A + B Load 8 – 16 ohm Headphone/Stereo headphone (230 mW/8 ohm)

EQUALIZER AMPLIFIER SECTION

Equalizer Amplifier Output:	Maximum Output: 10 V (at 47 k ohm Load) Rated Output: 150 mV Total harmonic wave distortion: below 0.002% (at 1 kHz, 8 V output)
Input Sensitivity/Input Impedance:	PHONO MM 2.5 mV 47 k ohm MC 200 μ V 100 ohm TUNER 150 mV 47 k ohm AUX, TAPE 150 mV 47 k ohm
RIAA Deviation:	PHONO within ± 0.3 dB (20 Hz – 100 kHz)

OVERALL CHARACTERISTICS

SN Ratio (IHFA Network):	PHONO MM 86 dB (input terminals short-circuited for 2.5 mV input) MC 70 dB (input terminals short-circuited for 250 μ V input)
Tone Control Adjustable Range:	TUNER, TAPE, AUX: 106 dB (input terminals short-circuited) BASS 100 Hz ± 8 dB TREBLE 10 kHz ± 8 dB
Loudness Characteristics:	Low frequency 100 Hz + 7 dB High frequency 10 kHz + 6 dB
AC OUTLET: (For U.S.A. and Canada)	SWITCHED x 2, 100 W (Total) UNSWITCHED x 1, 250 W
POWER SOURCE:	Germany and France AC 220 V, 50 Hz; U.K. AC 240 V, 50 Hz; U.S.A. AC 120 V, 60 Hz; Hong Kong AC 200V, 50 Hz
POWER CONSUMPTION:	150 W (U.S.A.); 330 W (IEC); 150 W (Hong Kong); 400 W Maximum Output, 290 VA (CSA)
DIMENSIONS:	434 mm (W) x 112 mm (H) x 390 mm (D) (including rubber feet, control knobs, and terminals)
WEIGHT:	9 kg

Design and specifications are subject to change without prior notice.

NOTE: The following codes correspond to the appropriate models.
E2 for Europe, EG for Germany, EK for U.K., E3 for U.S.A., E1 for Hong Kong, Singapore.
This Service Manual is prepared based on E2.

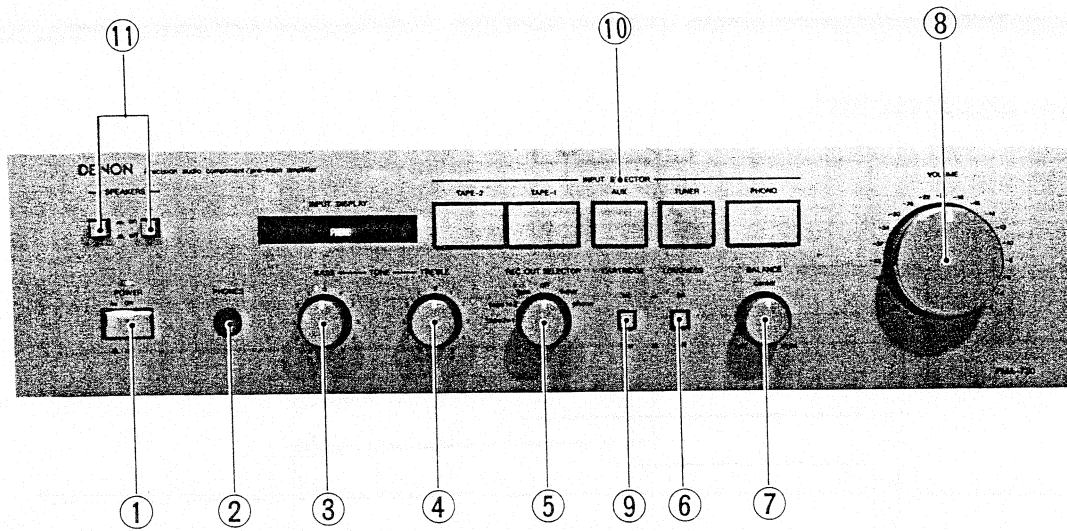

Fig. 1

- ① POWER (Power & LED Indicator)
- ② PHONES (Head Phones Jack)
- ③ BASS (Bass Control Knob)
- ④ TREBLE (Treble Control Knob)
- ⑤ RECOUT SELECTOR (REC Out Selector Switch)
- ⑥ LOUDNESS (Loudness Control Switch)
- ⑦ BALANCE (Balance Control Knob)
- ⑧ VOLUME (Volume Control Knob)
- ⑨ CARTRIDGE (Cartridge Chanveover Switch) " MC" " MM"
- ⑩ INPUT (INPUT Changeover Switch) "PHONO" "TUNER" "AUX" "TAPE-1" "TAPE-2"
- ⑪ SPEAKER (Speaker Changeover Switch)

BLOCK DIAGRAM

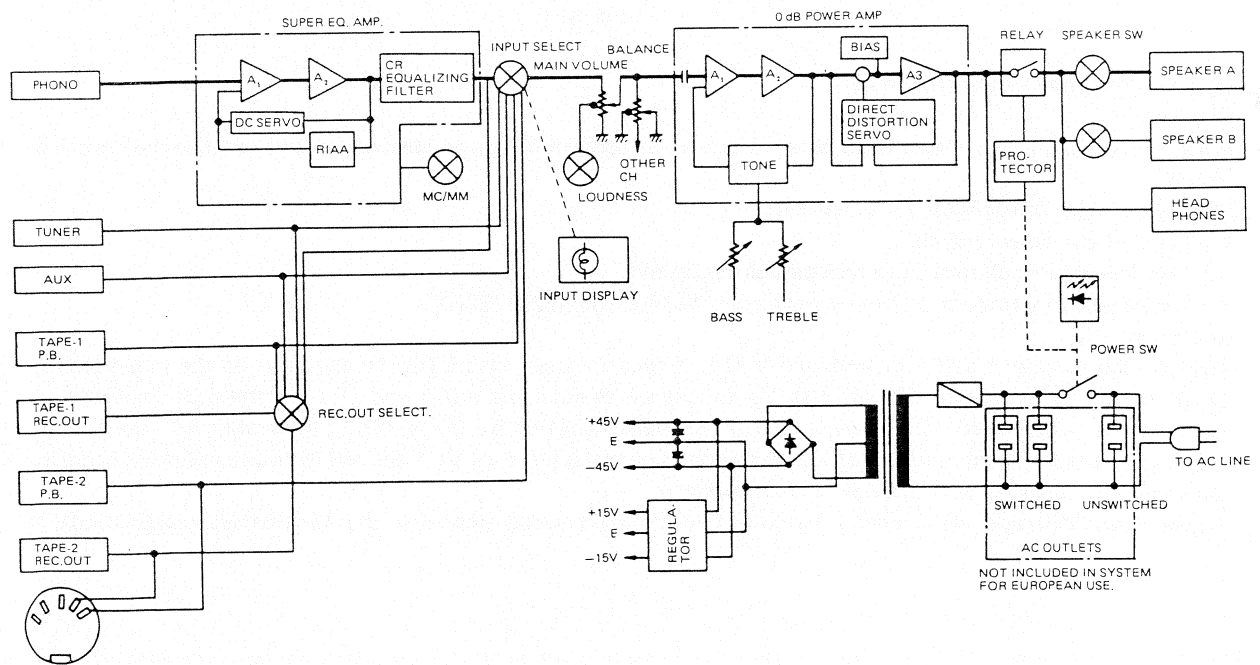

Fig. 2

METHOD OF ADJUSTMENTS

Schematic View of Tone & Power Adjustment

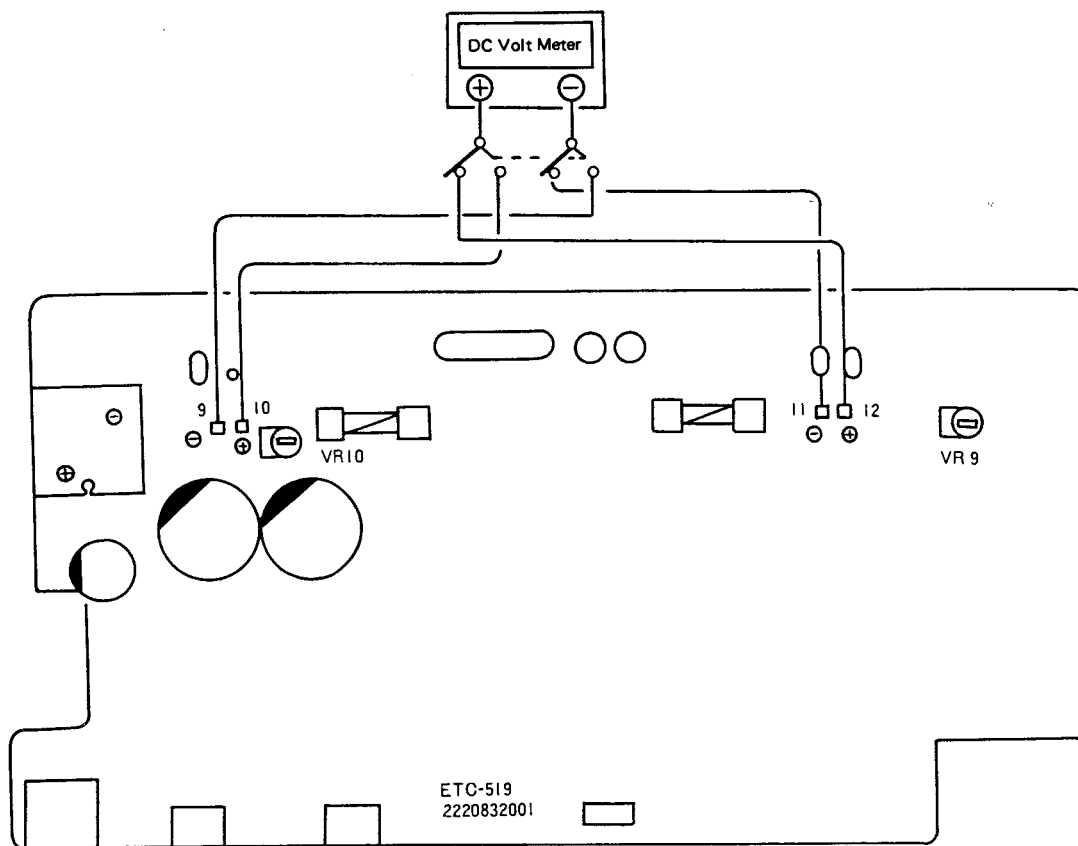

Fig. 3

Adjustment of Idling Current (ETC-519)

● Preparation

- (1) Keep PMA-730EX away from wind blown from an air conditioner or an electric fan and set it to the normal operating mode.
- (2) Set the switches of PMA-730EX as follows:
 - Turn off the power switch.
 - Turn the volume control counterclockwise to the end.
 - Disconnect the speakers, a dummy resistor or the like from PMA-730EX.

● Adjustment

- (1) Remove the top cover and turn VR9 and VR10 of tone & power unit ETC-519 clockwise to the minimum. Connect a DC voltmeter to test points (12) + and (11) – for the left channel and (10) + and (9) – for the right channel.
- (2) Connect the power cord to the power source (allowable range of AC 95 to 105 V, preferably AC 100 V) and turn on the power switch. When a period of less than one minute elapses, turn VR9 and VR10 counterclockwise and check that the voltmeter reads $5 \text{ mV} \pm 2 \text{ mV}$ at the test points.
- (3) Further, turn VR9 and VR10 when a period of two to three minutes elapses, so that the voltmeter reads $16 \text{ mV} \pm 1 \text{ mV}$.

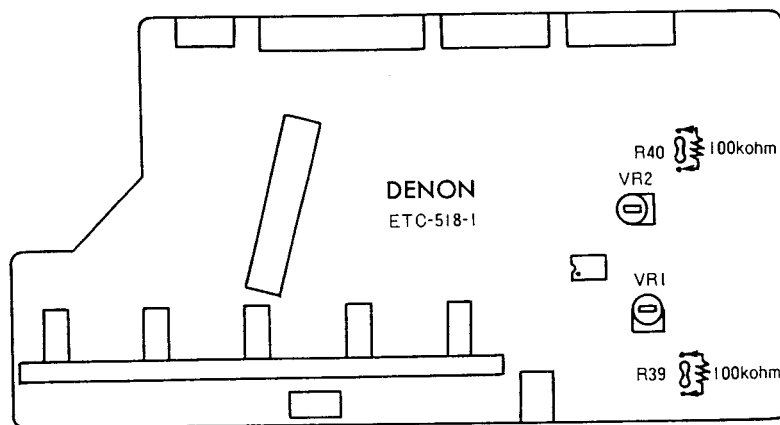
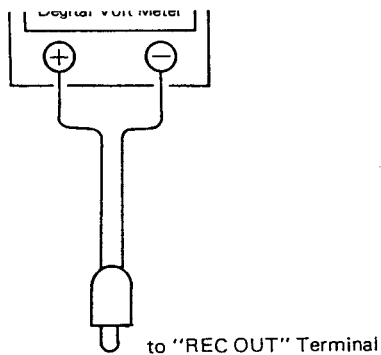

Fig. 4

Adjustment of Output Voltage from Equalizer (ETC-518)

- Preparation

- (1) Plug a pin into the PHONO input terminal.
- (2) Connect a digital voltmeter to the output terminals (R and L channels so that the voltmeter reads 0.01 to 1 mV (DC)).
- (3) Connect a 100 k ohm resistor between resistors 39 and 40 (10 M ohm each) of the unit in order to simplify the measurement.
- (4) Set the REC OUT selector to the PHONO position and turn the volume control to minimum.

- Adjustment

- (1) Turn on the power switch and follow the procedure below when a period of time of about 2 minutes elapses.
 - Turn VR1 so that the digital voltmeter reads 0.5 mV (DC) at the left channel.
 - Turn VR2 so that the digital voltmeter reads 0.5 mV (DC) at the right channel.

EXPLODED VIEW OF CHASSIS AND CABINET

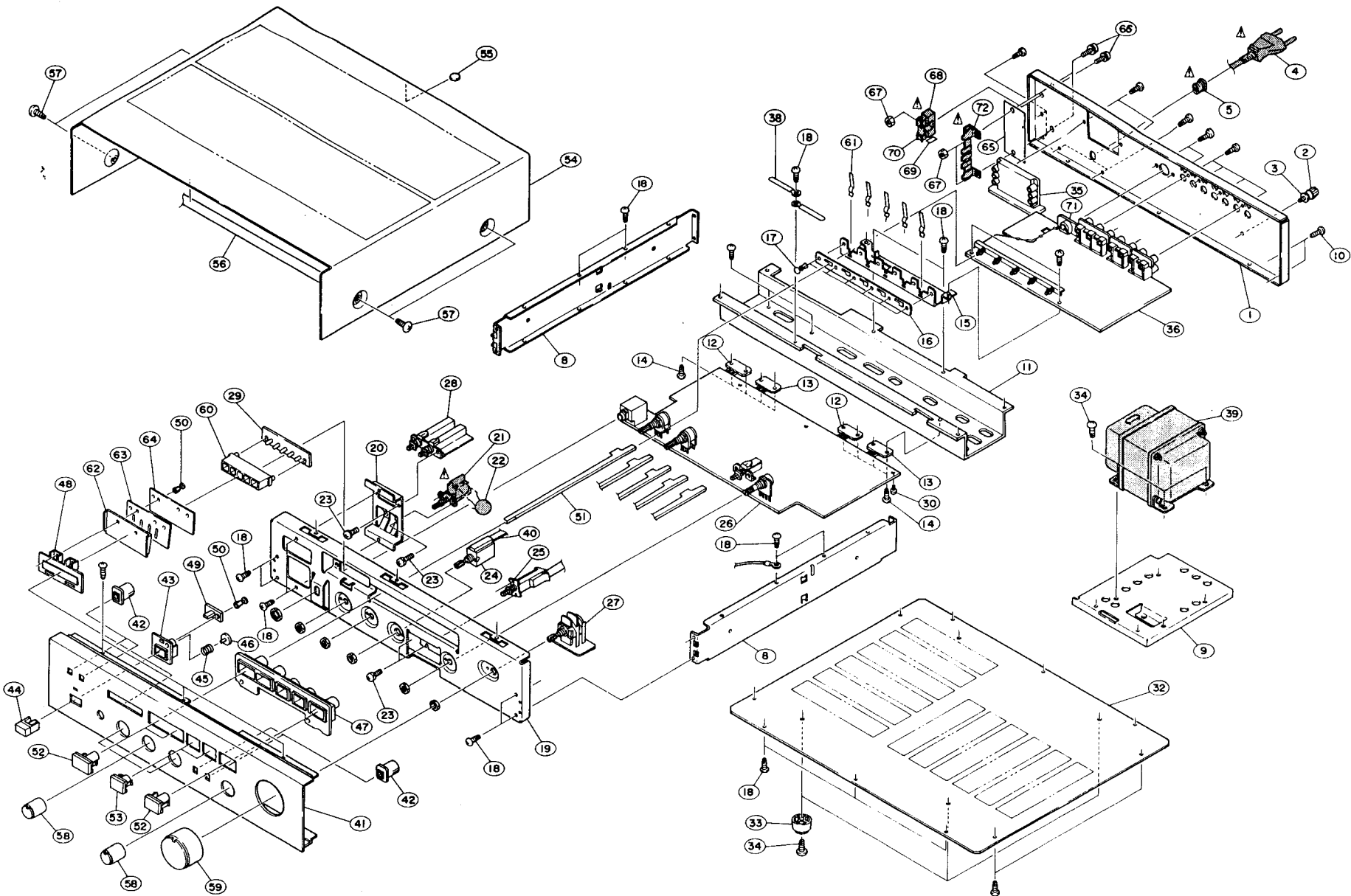

▲ Means important safety item, which must be replaced, when necessary, by a part specified or meeting the specification by the manufacturer.

EXPLODED VIEW PARTS LIST

NOTE: 1. See addendum list below for the parts with asterisk (*) on the Ref. No. and the other parts not included in this list.
2. This list is prepared based on E2.

Ref. No.	Part No.	Part Name & Descriptions	Ref. No.	Part No.	Part Name & Descriptions
*1	1050483003	BACK PANEL	40	4330052018	FLEXIBLE SLIDER
2	2050071016	TERMINAL ASS'Y	41	1440995004	FRONT PANEL
3	4770018001	WASHER (P-87)	42	1130306107	PUSH KNOB (LOUD) ASS'Y
△ * 4	2062002031	AC CORD	43	1460501009	PANEL BUSH (POWER)
△ * 5	4450020005	BUSHING	44	1130171222	PUSH KNOB ASS'Y
△ * 6			45	4630220007	SPRING
7	4730354015	TAPPING SCREW (2)3x8	46	1190014002	STOPPER
8	4110352000	SIDE CHASSIS	47	1460445016	PANEL BUSH (INPUT)
9	4110362003	TRANS CHASSIS	48	1460502008	WINDOW
10	4770064107	FIXING SCREW	*49	ETC0519K5	POWER LED UNIT
11	4170122212	RADIATOR	50	4770096007	PUSH RIVET
12	2720060001	TRANSISTOR 2SB755(O)/(R)	51	4121069007	CONNECTING BRACKET
13	2740082001	TRANSISTOR 2SD845(O)/(R)	52	1130290200	PUSH KNOB (INPUT)
14	4700012022	CROSS PAN SCREW WITH S. WASHER 3x12	53	1130291209	PUSH KNOB (SPEAKER)
15	4121068008	HOLD BRACKET	54	1020148006	TOP COVER
16	4410361103	SHEET	55	1040034006	STOPPER
17	4770210003	PUSH RIVET	56	1220069008	SPEAKER
18	4730354019	TAPPING SCREW (2)3x8	57	4734801005	TAPPING SCREW (TRUS) 4x8
19	4110350109	FRONT CHASSIS	58	1120321008	KNOB ASS'Y (A)
20	4121073006	SWITCH BRACKET	59	1120265216	KNOB
△ * 21	2124154021	POWER SWITCH	60	4530019208	LAMP HOLDER
△ * 22	2538003014	CAPACITOR 4700pF 400V	61	4630299009	SPRING
23	4700009006	CROSS PAN SCREW WITH S. WASHER 3x6	62	1460513204	WIND COVER
24	2120205000	ROTARY REMOTE	63	1430265003	FILTER
25	2124362004	1P. PUSH (REMOTE)	64	1430265016	FILTER
*26	ETC0519K	tone & POWER UNIT	65	4150088004	INSULATING SHEET
*27	ETC0519K2	VOLUME UNIT	66	4700042005	CROSS PAN SCREW WITH S. WASHER 3x8 (BLACK)
*28	ETC0519K3	SPEAKER SWITCH UNIT	67	4756006008	NUT φ3
*29	ETC0518K3	LED UNIT	68	2020013004	FUSE HOLDER
30	4700026005	TAPPING SCREW WITH W. 3x8	*69	5130654017	FUSE LABEL
31	4610121016	CUSHION	△ 70	2061015032	FUSE 2.5A
32	1050325103	BOTTOM COVER	71	2048059008	DIN JACK (5P)
33	1048001002	FOOT	72	2050089008	7P. W TERMINAL
34	4730455015	TAPPING SCREW (2)4x10	PACKING & ACCESSORIES (not included EXPLODED VIEW)		
*35	ETC0519K4	SPEAKER TERMINAL UNIT	a	5040064001	CABINET SHEET
*36	ETC0518K	INPUT & EQ. UNIT	b	5030262004	CUSHION
*37	4450033005	WIRE CLAMP BAND (USED 10)	c	5010755078	CARTON CASE
38	EP-4772	CORD HOLDER (USED 5)	d	5111016001	INST. MANUAL
△ * 39	2335357002	POWER TRANS			

ADDENDUM LIST

Ref. No.	Part Name	Part No.			
		EG for Germany	EK for U.K.	E3 for U.S.A.	E1 for Hong Kong, Singapore
1	BACK PANEL	1050483003	1050483003		1050493006
△ 4	AC CORD	2062002031	2062020000		2006031026
△ 5	BUSHING	4450020005	MD-2982H		MD-3802
△ 6	AC OUTLET UNIT				ETC0518M2
△ 21	POWER SWITCH	2124154021	2124154021		2124154021
△ 22	CAPACITOR	2538003014	2538003014		2538003014
26	tone & POWER UNIT	ETC0519K	ETC0519K		ETC0519M
27	VOLUME UNIT	ETC0519K2	ETC0519K2		ETC0519M2
28	SPEAKER SWITCH UNIT	ETC0519K3	ETC0519K3		ETC0519M3
29	LED UNIT	ETC0518K3	ETC0518K3		ETC0518M3
35	SPEAKER TERMINAL UNIT	ETC0519K4	ETC0519K4		ETC0519M4
36	INPUT & EQ. UNIT	ETC0518K	ETC0518K		ETC0518M
△ 39	POWER TRANS	2335357002	2335367005		2335366006
49	POWER LED UNIT	ETC0519K5	ETC0519K5		ETC0519M5
65	INSULATING SHEET	4150088004	4150088004		-
72	7P. W TERMINAL	2050089008	2050089008		-
△ 73	VOLTAGE SELECTOR SWITCH				2120186006
74	CROSS PAN SCREW 3x6 (BLACK)	-	-		4711303034
75	TOOTH WASHER φ3	-	4753001051		-
76	WIRE ASS'Y	-	2030176151		-
77	VOLTAGE LABEL	-	5130362008		-
78	BLIND SHEET	-	5130348006		-
79	CAUTION SHEET	-	5130364006		-
80	TOOTH WASHER φ4	-	4753100004		-
81	EARTH LABEL	-	5130140000		-
PACKING & ACCESSORIES (not included EXPLODED VIEW)					
e	IMPORTANT LABEL	-	5130372001		-
f	GUARANTEE CARD	-	5150230000		-

PRINTED WIRING BOARD PATTERNS AND PARTS LIST

ETC-518K, M INPUT & EQ. UNIT

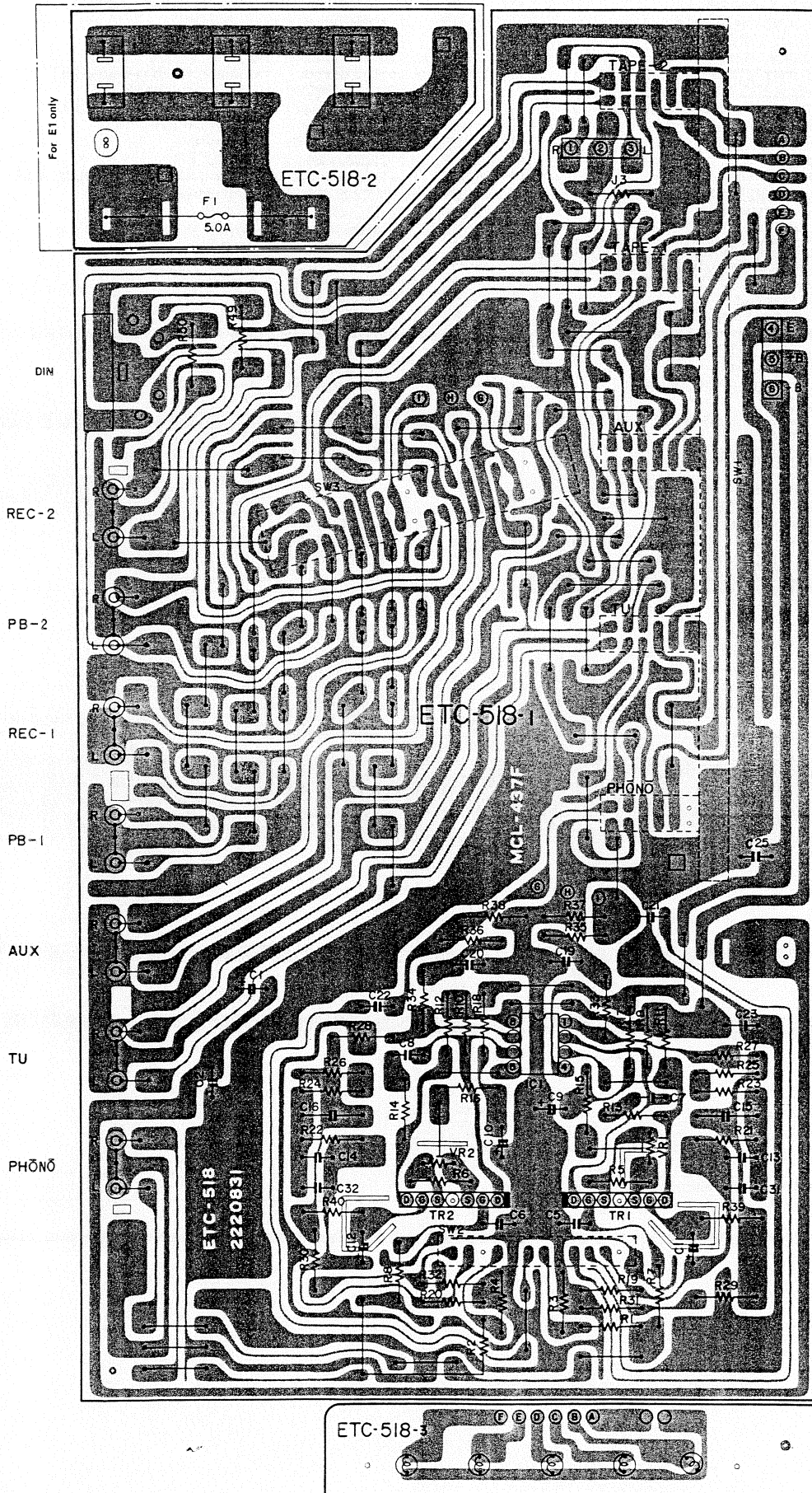

Ref. No.	Part No.	Part Name & Descriptions	
SEMICONDUCTORS			
IC001	2650034013	NJM4559D	INTEGRATED CIRCUIT
IC002	2650034013	NJM4559D	INTEGRATED CIRCUIT
IC003	2680031002	TA78L015P	INTEGRATED CIRCUIT
IC005	2630209004	μPC1237H	INTEGRATED CIRCUIT
TR001	2710094016	2SA970(BL)	TRANSISTOR
TR002	2710094016	2SA970(BL)	TRANSISTOR
TR003	2710094016	2SA970(BL)	TRANSISTOR
TR004	2710094016	2SA970(BL)	TRANSISTOR
TR005	2730158013	2SC1775(F)	TRANSISTOR
TR006	2730158013	2SC1775(F)	TRANSISTOR
TR007	2730158013	2SC1775(F)	TRANSISTOR
TR008	2730158013	2SC1775(F)	TRANSISTOR
TR009	2710131005	2SA988(F)	TRANSISTOR
TR010	2710131005	2SA988(F)	TRANSISTOR
TR011	2710072009	2SA850(D)	TRANSISTOR
TR012	2710072009	2SA850(D)	TRANSISTOR
TR013	2730163011	2SC1735(D)	TRANSISTOR
TR014	2730163011	2SC1735(D)	TRANSISTOR
TR015	2730198015	2SC1815(BL)	TRANSISTOR
TR016	2730198015	2SC1815(BL)	TRANSISTOR
TR017	2710072009	2SA850(D)	TRANSISTOR
TR018	2710072009	2SA850(D)	TRANSISTOR
TR019	2730163011	2SC1735(D)	TRANSISTOR
TR020	2730163011	2SC1735(D)	TRANSISTOR
TR021	2730163011	2SC1735(D)	TRANSISTOR
TR023	2730236029	2SC2824(Y/O)	TRANSISTOR
TR024	2730236029	2SC2824(Y/O)	TRANSISTOR
TR025	2710135027	2SA1184(Y/O)	TRANSISTOR
TR026	2710135027	2SA1184(Y/O)	TRANSISTOR
TR031	2710102005	2SA1015(Y)	TRANSISTOR
TR032	2710105002	2SA966(Y)	TRANSISTOR
TR033	2750018023	2SK30A(R)/(O)	FIELD EFFECT TRANSISTOR
TR034	2730236029	2SC2824(Y/O)	TRANSISTOR
D001	2760216019	KB-265	DIODE
D002	2760216019	KB-265	DIODE
D003	2760049008	1S2076	DIODE
D004	2760049008	1S2076	DIODE
D005	2760224001	HZ-30	DIODE
D006	2760224001	HZ-30	DIODE
D007	2760049008	1S2076	DIODE
D008	2760049008	1S2076	DIODE
D009	2760049008	1S2076	DIODE
D010	2760049008	1S2076	DIODE
D011	2760049008	1S2076	DIODE
D012	2760049008	1S2076	DIODE
D013	2760299007	HZ3C2	DIODE
D014	2760299007	HZ3C2	DIODE
D015	2760299007	HZ3C2	DIODE
D016	2760299007	HZ3C2	DIODE
D019	2760049011	1S2076A	DIODE
D020	2760191008	W03C	DIODE
D021	2760191008	W03C	DIODE
D022	2760298008	M4C-41	DIODE
D023	3939149013	PR5531K RED	LIGHT EMITTING DIODE
D030	2760191008	W03C	DIODE
D031	2760314018	HZ-27	DIODE
RESISTORS (not included ±5%, ¼W, Carbon Film Type)			
VR001	2110244000	VARIABLE RESISTOR 100 k ohm MAIN	
VR003	2110245009	VARIABLE RESISTOR 250 k ohm BALANCE	
VR005	2110253004	VARIABLE RESISTOR 50 k ohm TREBLE	
VR007	2110246011	VARIABLE RESISTOR 100 k ohm BASS	
VR009	2116025058	SEMI FIXED RESISTOR 10 k ohm	
VR010	2116025058	SEMI FIXED RESISTOR 10 k ohm	
R007	2420203003	10 M ohm ±10% ¼W CARBON COMPOSIT	
R008	2420203003	10 M ohm ±10% ¼W CARBON COMPOSIT	
R029	2410153008	47 ohm ±5% ½W CARBON FILM	
R030	2410153008	47 ohm ±5% ½W CARBON FILM	
R031	2410153008	47 ohm ±5% ½W CARBON FILM	
R032	2410153008	47 ohm ±5% ½W CARBON FILM	

Ref. No.	Part No.	Part Name & Descriptions	
R063	2440046020	27 k ohm ±5% 1W	METAL OXIDE FILM
R064	2440046020	27 k ohm ±5% 1W	METAL OXIDE FILM
R067	2412314023	470 ohm ±5% ¼W	CARBON FILM (FUSIBLE)
R068	2412314023	470 ohm ±5% ¼W	CARBON FILM (FUSIBLE)
R071	2440046020	2.7 k ohm ±5% 1W	METAL OXIDE FILM
R072	2440046020	2.7 k ohm ±5% 1W	METAL OXIDE FILM
R073	2412321003	1 k ohm ±5% ¼W	CARBON FILM (FUSIBLE)
R074	2412321003	1 k ohm ±5% ¼W	CARBON FILM (FUSIBLE)
R089	2412313053	1 k ohm ±2% ¼W	CARBON FILM (FUSIBLE)
R090	2412313053	1 k ohm ±2% ¼W	CARBON FILM (FUSIBLE)
R091	2412313053	1 k ohm ±2% ¼W	CARBON FILM (FUSIBLE)
R092	2412313053	1 k ohm ±2% ¼W	CARBON FILM (FUSIBLE)
R105	2440037026	470 ohm ±5% 1W	METAL OXIDE FILM
R106	2440037026	470 ohm ±5% 1W	METAL OXIDE FILM
R111	2432026016	0.33/0.33 ohm 10%	3.15W WIRE WOUND
R112	2432026016	0.33/0.33 ohm 10%	3.15W WIRE WOUND
R117	2440017020	10 ohm ±5% 1W	METAL OXIDE FILM
R118	2440017020	10 ohm ±5% 1W	METAL OXIDE FILM
R121	2412313006	47 ohm ±2% ¼W	CARBON FILM (FUSIBLE)
R125	2410213003	15 k ohm ±5% ¼W	CARBON FILM
R126	2420197009	3.3 M ohm ±10% ¼W	CARBON COMPOSIT
R134	2440040026	820 ohm ±5% 1W	METAL OXIDE FILM
R135	2440040026	820 ohm ±5% 1W	METAL OXIDE FILM
R136	2442012023	4.7 ohm ±5% ½W	METAL OXIDE FILM
R137	2440030023	120 ohm ±5% 1W	METAL OXIDE FILM
R138	2440030023	120 ohm ±5% 1W	METAL OXIDE FILM
R151	2410159002	82 ohm ±5% ¼W	CARBON FILM
R154	2410187003	1.2 k ohm ±5% ¼W	CARBON FILM
CAPACITORS (not included Ceramic, 50V Type)			
C003	2551122037	0.082μF ±5%	50V PLASTIC FILM
C004	2551122037	0.082μF ±5%	50V PLASTIC FILM
C005	2544135002	47μF	16V ELECTROLYTIC
C007	2544146004	1μF	50V ELECTROLYTIC
C008	2544146004	1μF	50V ELECTROLYTIC
C013	2544146004	1μF	50V ELECTROLYTIC
C014	2544146004	1μF	50V ELECTROLYTIC
C015	2544059007	100μF	63V ELECTROLYTIC
C017	2551120084	0.0047μF ±5%	50V PLASTIC FILM
C018	2551120084	0.0047μF ±5%	50V PLASTIC FILM
C019	2551120055	0.0027μF ±5%	50V PLASTIC FILM
C020	2551120055	0.0027μF ±5%	50V PLASTIC FILM
C023	2551120013	0.0012μF ±5%	50V PLASTIC FILM
C024	2551120013	0.0012μF ±5%	50V PLASTIC FILM
C025	2551121096	0.039μF ±5%	50V PLASTIC FILM
C026	2551121096	0.039μF ±5%	50V PLASTIC FILM
C027	2551122095	0.27μF ±5%	50V PLASTIC FILM
C028	2551122095	0.27μF ±5%	50V PLASTIC FILM
C031	2544132005	10μF	16V ELECTROLYTIC
C032	2544132005	10μF	16V ELECTROLYTIC
C033	2544007004	1000μF	6.3V ELECTROLYTIC
C034	2544007004	1000μF	6.3V ELECTROLYTIC
C037	2544019005	220μF	16V ELECTROLYTIC
C038	2544019005	220μF	16V ELECTROLYTIC
C039	2544019005	220μF	16V ELECTROLYTIC
C040	2544019005	220μF	16V ELECTROLYTIC
C049	2544134003	33μF	16V ELECTROLYTIC
C050	2544134003	33μF	16V ELECTROLYTIC
C051	2544134003	33μF	16V ELECTROLYTIC
C052	2544134003	33μF	16V ELECTROLYTIC
C067	2544059078	2.2μF	63V ELECTROLYTIC
C071	2544059036	4.7μF	63V ELECTROLYTIC
C075	2544059036	4.7μF	63V ELECTROLYTIC

(Con.)

Ref. No.	Part No.	Part Name & Descriptions
C077	2551122040	0.1μF ±5% 50V PLASTIC FILM
C078	2551122040	0.1μF ±5% 50V PLASTIC FILM
C079	2544059078	2.2μF 63V ELECTROLYTIC
C081	2551122011	0.056μF ±5% 50V PLASTIC FILM
C082	2551122011	0.056μF ±5% 50V PLASTIC FILM
C083	2544005006	330μF 6.3V ELECTROLYTIC
C084	2544147003	2.2μF 50V ELECTROLYTIC
C085	2544146004	1μF 50V ELECTROLYTIC
C086	2544128006	22μF 10V ELECTROLYTIC
C090	2544038002	100μF 35V ELECTROLYTIC
C091	2546067000	8200μF ±2% 56V ELECTROLYTIC
C092	2546067000	8200μF ±2% 56V ELECTROLYTIC
C093	2531053003	0.01μF +100,-0% 500V CERAMIC
C097	2544051005	220μF 50V ELECTROLYTIC
C098	2544146004	1μF 50V ELECTROLYTIC
OTHER PARTS		
	2220832001	P.W. BOARD
	2090047903	JUMPER WIRE USED 41
	2050134908	TERMINAL USED 15
	2090008104	JUMPER P=15mm USED 4
	2035622008	3P. CONNECTOR BASE
	2034146006	3P. CONNECTOR CORD
	2030170005	1P. CONTACT
SW001	2124363003	1P. PUSH SWITCH
SW003	2124364002	2P. PUSH SWITCH
	2048046008	HEAD PHONE JACK
	2050151004	8P. PUSH TERMINAL <i>SP-Terminal</i>

Ref. No.	Part No.	Part Name & Descriptions
	EP-5870	FUSE HOLDER USED 4
F001	EP-713210	FUSE (5A) USED 2
F002		
L001	2320017001	INDUCTOR 1μH
L002	2320017001	INDUCTOR 1μH
RL001	2140037009	RELAY

ETC-518M PARTS LIST for E1

Ref. No.	Part No.	Part Name & Descriptions
	2020013004	FUSE HOLDER (ADD)
	5130654017	FUSE LABEL (ADD)
	2061015032	FUSE 2.5A (ADD)

ETC-518 [] PARTS LIST for []

Ref. No.	Part No.	Part Name & Descriptions

when necessary, by a part specified or meeting the specification by the manufacturer.

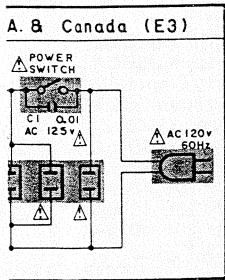
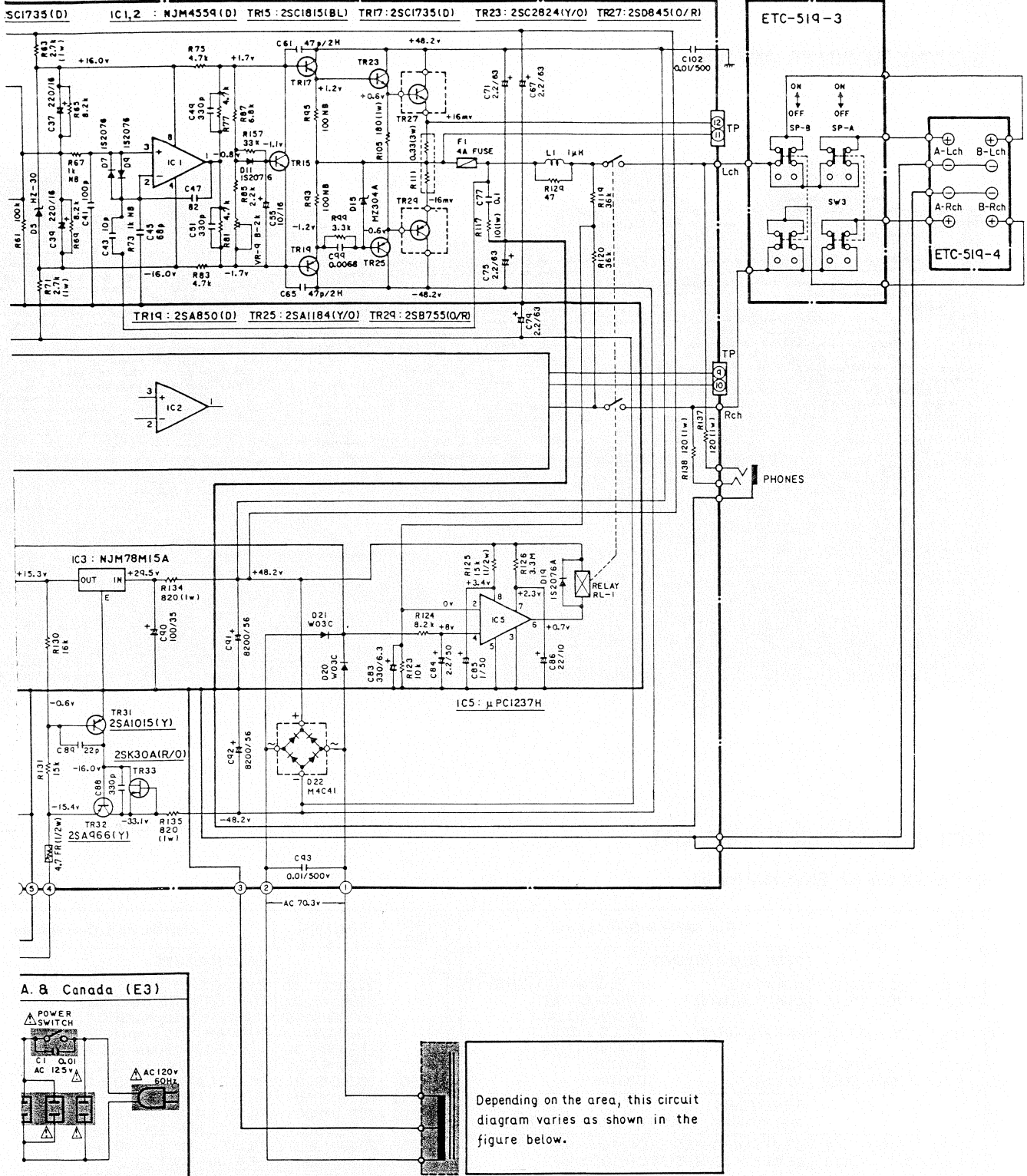

Depending on the area, this circuit diagram varies as shown in the figure below.

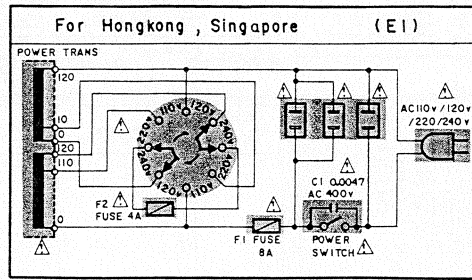
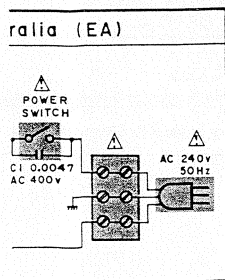

NOTES
 ALL RESISTANCE VALUES IN OHM K = 1,000 OHM M = 1,000,000 OHM
 ALL CAPACITANCE VALUES IN MICRO FARAD P = MICRO-MICRO FARAD
 EACH VOLTAGE AND CURRENT ARE MEASURED AT NO SIGNAL INPUT CONDITION.
 CIRCUIT AND PARTS ARE SUBJECT TO CHANGE WITHOUT PRIOR NOTICE.

ETC-519K, M POWER AMP UNIT

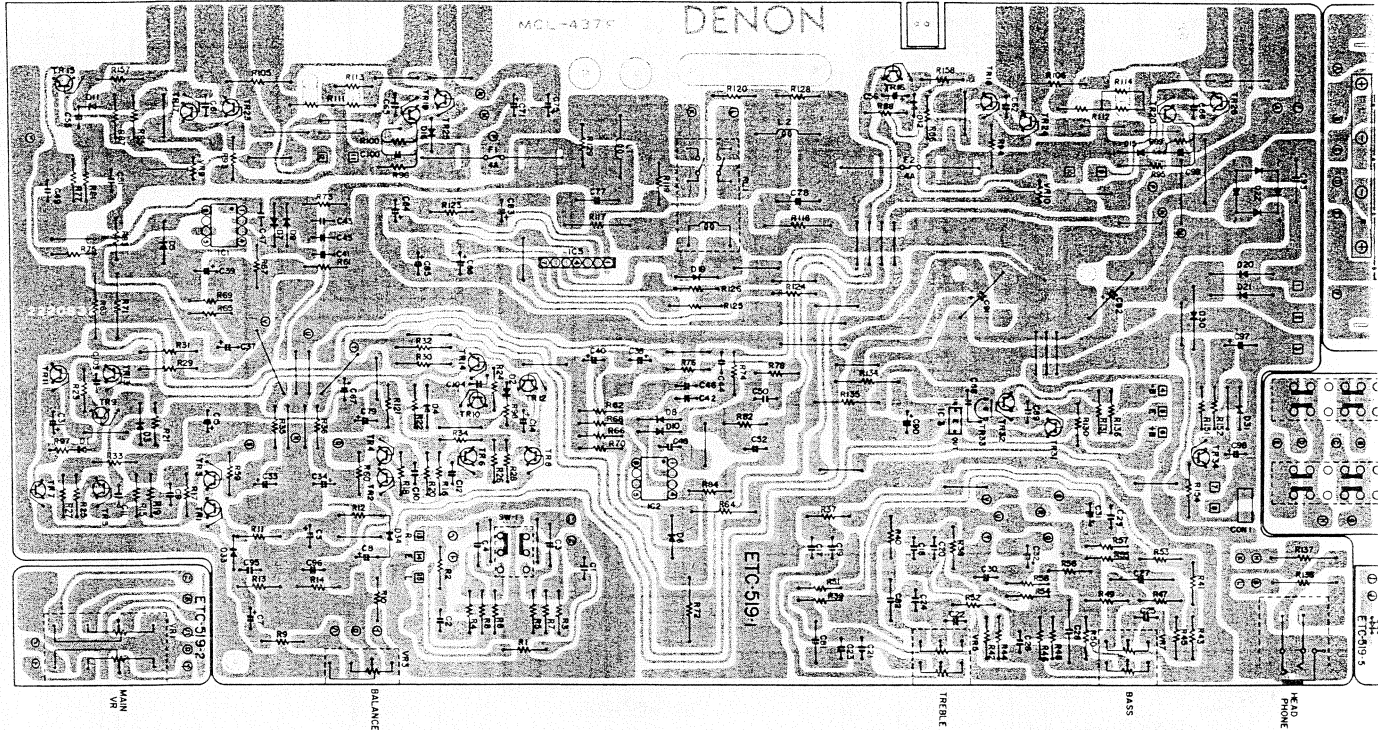

TONE & POWER UNIT PARTS LIST

ETC-519K for E2, EK, 519M for E1

Ref. No.	Part No.	Part Name & Descriptions	
SEMICONDUCTORS			
IC001	2630081002	NJM4558D	INTEGRATED CIRCUIT
TR001	2750036005	2SK270(GR/BL)	FIELD EFFECT TRANSISTOR
TR002	2750036005	2SK270(GR/BL)	FIELD EFFECT TRANSISTOR
D007	2760049008	1S2076	DIODE
D008	2760049008	1S2076	DIODE
RESISTORS (not included ±5%, ¼W, Carbon Film Type)			
VR001	2116025016	SEMI FIXED RESISTOR 100 ohm	
VR002	2116025016	SEMI FIXED RESISTOR 100 ohm	
R021	2412032046	4.7 k ohm ±2% ¼W CARBON FILM	
R022	2412032046	4.7 k ohm ±2% ¼W CARBON FILM	
R023	2412320033	56 k ohm ±2% ¼W CARBON FILM	
R024	2412320033	56 k ohm ±2% ¼W CARBON FILM	
R039	2420203003	10 M ohm ±10% ¼W CARBON COMPOSIT	
R040	2420203003	10 M ohm ±10% ¼W CARBON COMPOSIT	
CAPACITORS (not included Ceramic 50V Type)			
C001	2544145005	0.47µF	50V ELECTROLYTIC
C002	2544145005	0.47µF	50V ELECTROLYTIC
C009	2544135002	47µF	16V ELECTROLYTIC
C010	2544135002	47µF	16V ELECTROLYTIC
C011	2549011024	10µF	50V ELECTROLYTIC
C012	2549011024	10µF	50V ELECTROLYTIC
C015	2551122011	0.056µF ±5%	50V PLASTIC FILM
C016	2551122011	0.056µF ±5%	50V PLASTIC FILM
C019	2551120055	0.0027µF ±5%	50V PLASTIC FILM
C020	2551120055	0.0027µF ±5%	50V PLASTIC FILM
C021	2551120055	0.0027µF ±5%	50V PLASTIC FILM
C022	2551120055	0.0027µF ±5%	50V PLASTIC FILM
C031	2551121041	0.015µF ±5%	50V PLASTIC FILM
C032	2551121041	0.015µF ±5%	50V PLASTIC FILM

Ref. No.	Part No.	Part Name & Descriptions	
OTHER PARTS			
	2220831002	P.W. BOARD	
	2090047903	JUMPER WIRE USED 63	
	2090008146	JUMPER P=5mm USED 1	
	2090008117	JUMPER P=12.5mm USED 1	
	2090008104	JUMPER P=15mm USED 6	
	2050082034	3P. TERMINAL USED 2	
PL001	3930079001	PILOT LAMP 28V 40 mA	
PL002	3930079001	PILOT LAMP 28V 40 mA	
PL003	3930079001	PILOT LAMP 28V 40 mA	
PL004	3930079001	PILOT LAMP 28V 40 mA	
PL005	3930079001	PILOT LAMP 28V 40 mA	
SW001	2124365001	5P. PUSH SWITCH	
SW002	2124320007	SLIDE SW (4-2) REMOTE	
SW003	2124331006	SLIDE SW (4-6) REMOTE	
	2050150005	4P. CONNECTOR BASE USED 2	
	2050152003	6P. CONNECTOR BASE	
	EP-5667H1	TERMINAL USED 4	

ETC-519 PARTS LIST for

Ref. No.	Part No.	Part Name & Descriptions

WIRING DIAGRAM

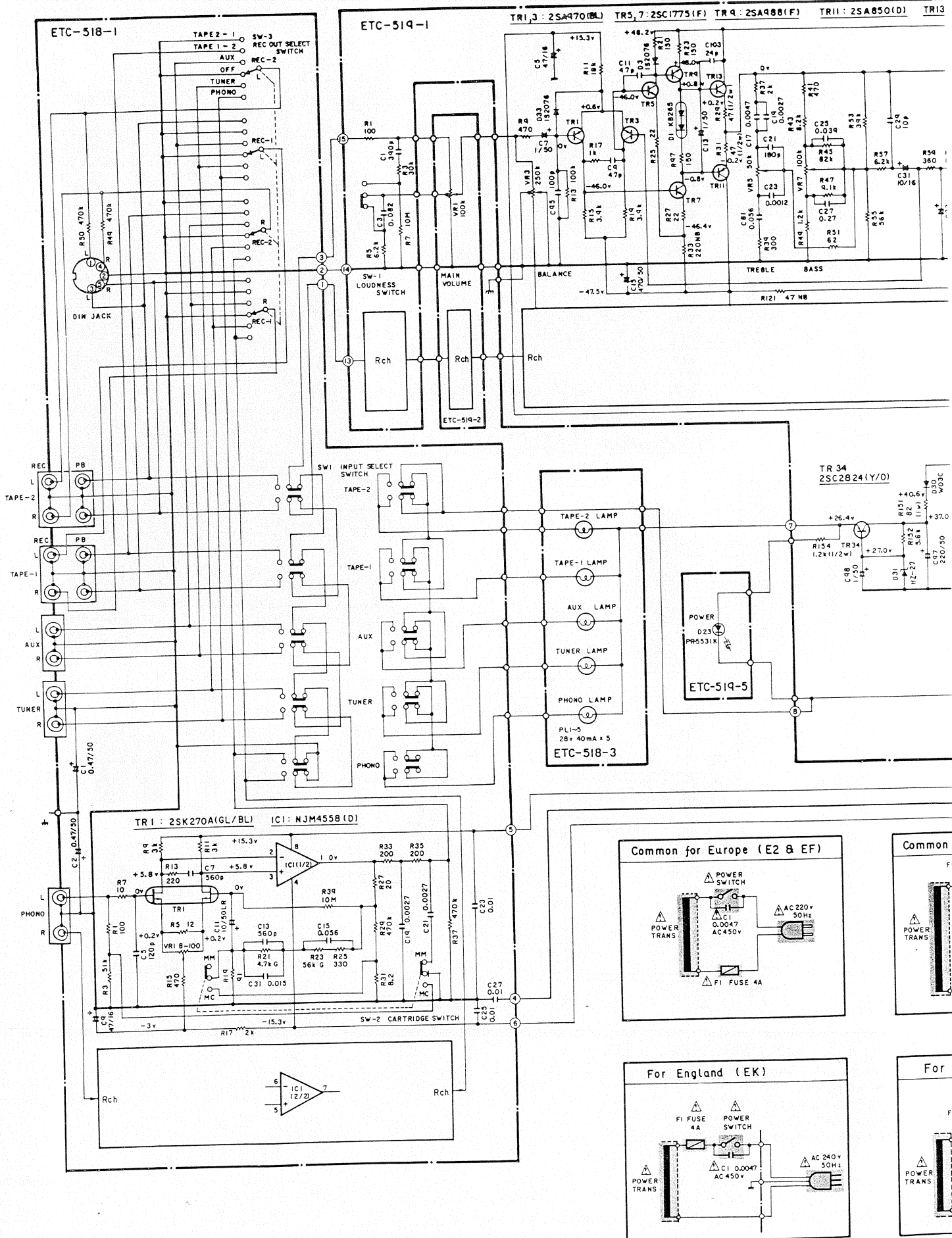

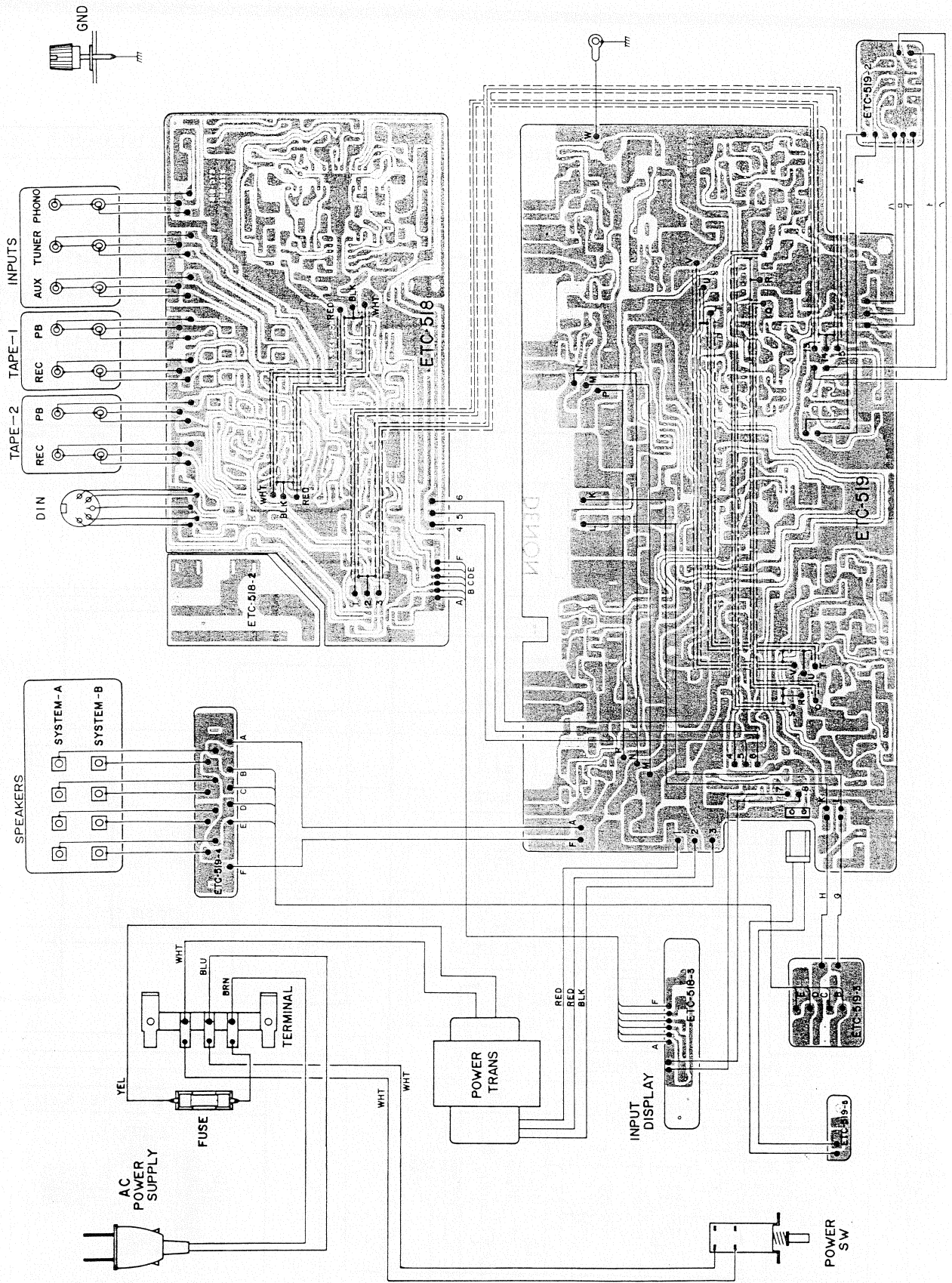

NIPPON COLUMBIA CO., LTD.
 No. 14-14, 4-CHOME AKASAKA,
 MINATO-KU, TOKYO 107, JAPAN
 TEL: 03-584-8111
 TLX: JAPANOLA J22591
 CABLE: NIPPONCOLUMBIA TOKYO